

Technical part



EGO Typ G



EGO Typ F

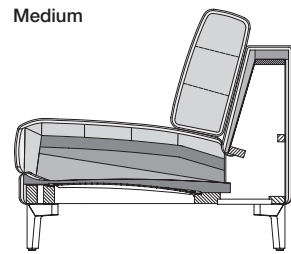

Medium

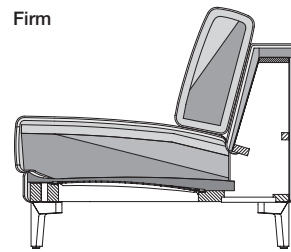

Firm

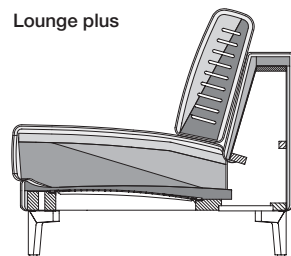

Lounge plus

- Wooden inner frame
- No-sag spring support (upholstered seat and upholstered bench without spring support). Exceptions are the EPT and PB models and the PSZ, where high-quality polyurethane foams are used for constructive reasons
- Seat pad in polyurethane foam
- Back pad in polyurethane foam
- Body cover quilted underneath with non-woven polyester
- **Seat comfort medium:**
 - › Seat made of polyurethane foam, built up in layers to achieve a balance of different heights and firmnesses. Covered with a mat to achieve a down-like effect, which has chambers worked into it and is filled with foam rods and polyester fibres
 - › Seat cover quilted underneath with non-woven polyester
 - › Backrest cushions: Loose backrest cushions that are down-like in nature, comprising chambers with a filling made of foam rods and polyester fibre balls.
- **Seat comfort firm:**
 - › Seat made of high-quality cold foam, built up in layers and coordinated in different thick-

- nesses and hardnesses with a polyester fleece covering.
- › Seat cover quilted underneath with non-woven polyester
- › Backrest cushions: Backrest cushions made of polyurethane foam covered with a fleece/foam composite pad.
- **Seat comfort lounge plus:**
 - › Seat made of high-quality cold foam, built up in layers and coordinated in different thicknesses and hardnesses with a polyester fleece covering.
 - › Seat cover quilted underneath with non-woven polyester
 - › Backrest cushions: Backrest cushions made of polyurethane foam covered with a fleece/foam composite pad.
- Coupling for modular sofa elements with suspension fitting
- Legs in metal or wood in different finishes
- ! High-quality, casual upholstery that forms waves/leaves indentations that are typical of the material. All measurements are approximate.

Side element narrow

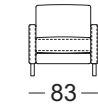

— 83 —

Side element wide

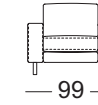

— 99 —

Side section with cushion

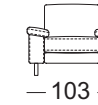

— 103 —

Adjustable side element

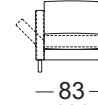

— 83 —

— 129 —

SE EGO

SOB EGO/SB 126

SOB EGO/SB 147

SOB EGO/SB 168

SOB EGO/SB 189

SOB EGO/SB 210

ASO EGO/SB 105

ASO EGO/SB 126

ASO EGO/SB 147

ASO EGO/SB 168

ASO EGO/SB 189

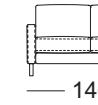

— 146 —

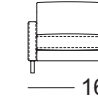

— 167 —

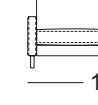

— 188 —

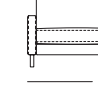

— 209 —

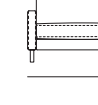

— 230 —

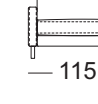

— 115 —

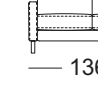

— 136 —

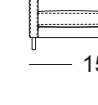

— 157 —

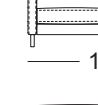

— 178 —

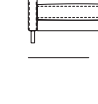

— 199 —

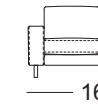

— 162 —

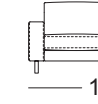

— 183 —

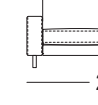

— 204 —

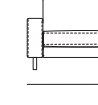

— 225 —

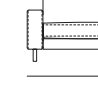

— 246 —

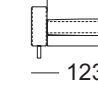

— 123 —

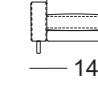

— 144 —

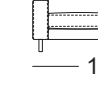

— 165 —

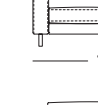

— 186 —

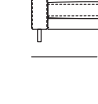

— 207 —

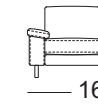

— 166 —

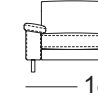

— 187 —

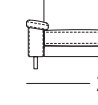

— 208 —

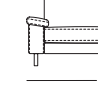

— 229 —

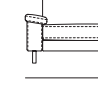

— 250 —

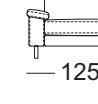

— 125 —

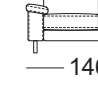

— 146 —

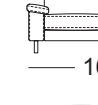

— 167 —

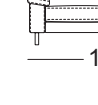

— 188 —

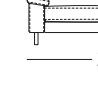

— 209 —

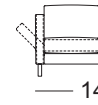

— 146 —

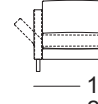

— 167 —

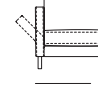

— 188 —

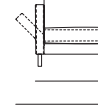

— 209 —

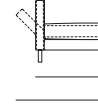

— 230 —

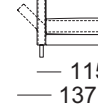

— 115 —

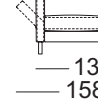

— 136 —

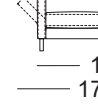

— 157 —

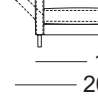

— 178 —

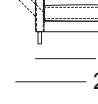

— 199 —

— 221 —

Side element narrow Side element wide Side section with cushion Adjustable side element

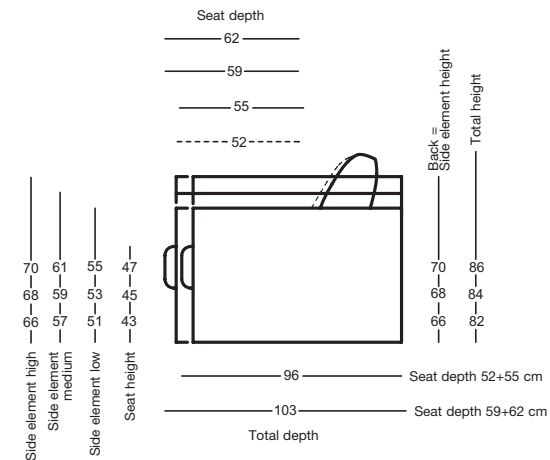
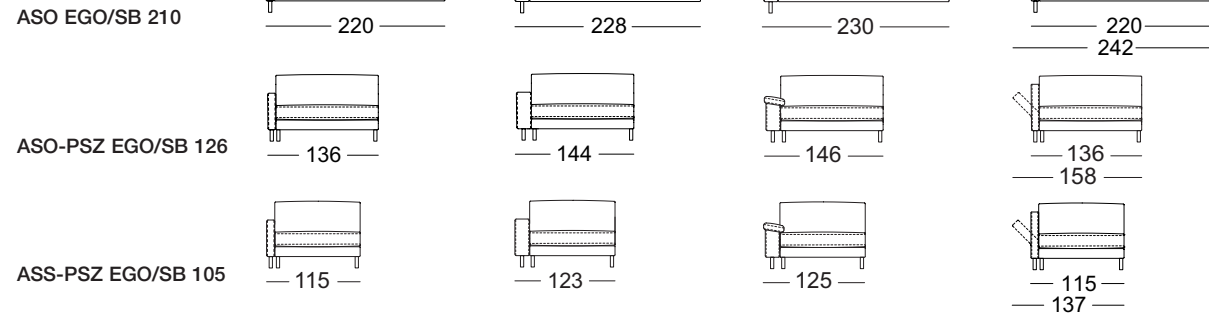

ASS-PSZ:

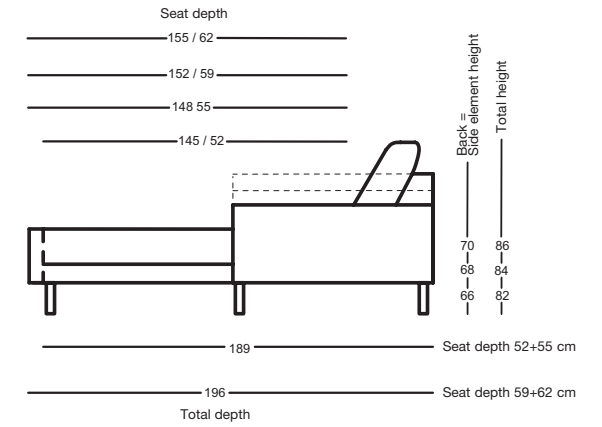

The specified seat height dimensions are measured at the front edge of the seat upholstery. The measurements are approximate. Upholstery dimensions may vary depending on the different elasticities of the cover fabrics, different upholstery structures and usage behaviour.

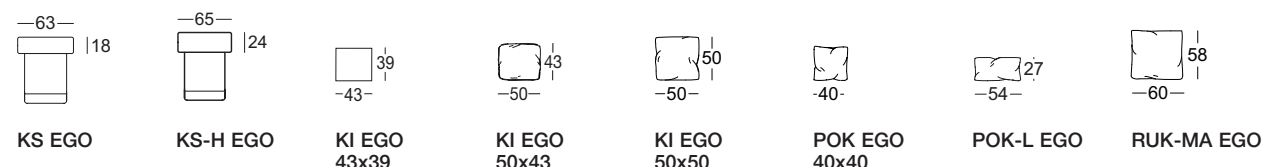
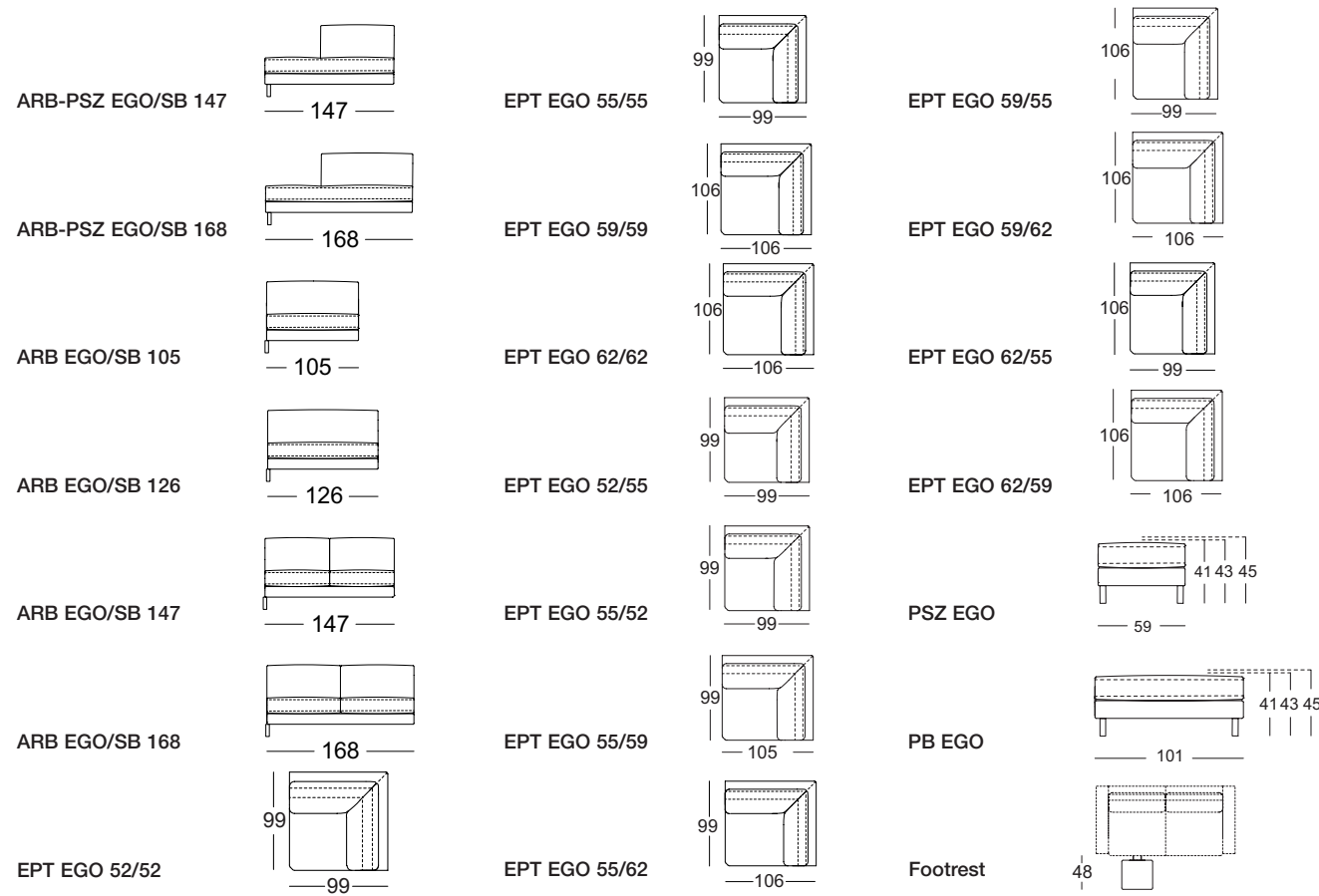

Combination examples

